

# LCM Specification

Preliminary specification

Final Specification

Project No. 项目编号	H043A2WQIST5R40		
Customer 客户名称			
Module No. 客户型号			
Product type 产品内容	TFT LCD Module 480 x 3RGB x 272 Dots 4.3" TFT LCD		
Signature by customer: 客户确认签章:			
<input type="checkbox"/> Trial production <input type="checkbox"/> Mass production			
编 制	电子审核	结构审核	批 准
Y. L			

深圳市鑫洪泰电子科技有限公司

Shenzhen Hot Display Technology Co., Ltd

**1 Document revision history :**

DOCUMENT REVISION	DATE	DESCRIPTION	PREPARED BY	APPROVED BY
A	2019-4-10	First Release.	Y.L	

## 1. General Feature:

Item	Standard Value	Unit
Display Size	4.3"	--
Number of Pixels	480(H)x3(RGB)*272(V)	--
Active Area	95.04(H) *53.86(V)	mm
Outline Dimension	105.50(H) ×67.20× 4.0(V)	mm
Viewing Direction	FULL O'Clock	-
Interface	TTL 8/24 bit interface	-
Driver IC	SC7283	-
Driver Condition	VCI=3.3V	V
Backlight	White LED	-
Touch Panel	Resistive Touch Panel	-
Operation Temperature	-20~70	°C
Storage Temperature	-30~80	°C

## 2.Outline Dimensions

\*\*\* Do not display the fixed pattern for a long time because it may develop image sticking due to the LCM structure. If the screen is displayed with fixed pattern, use a screen saver. It is recommended to display the fixed mode for no more than 2 minutes or less.

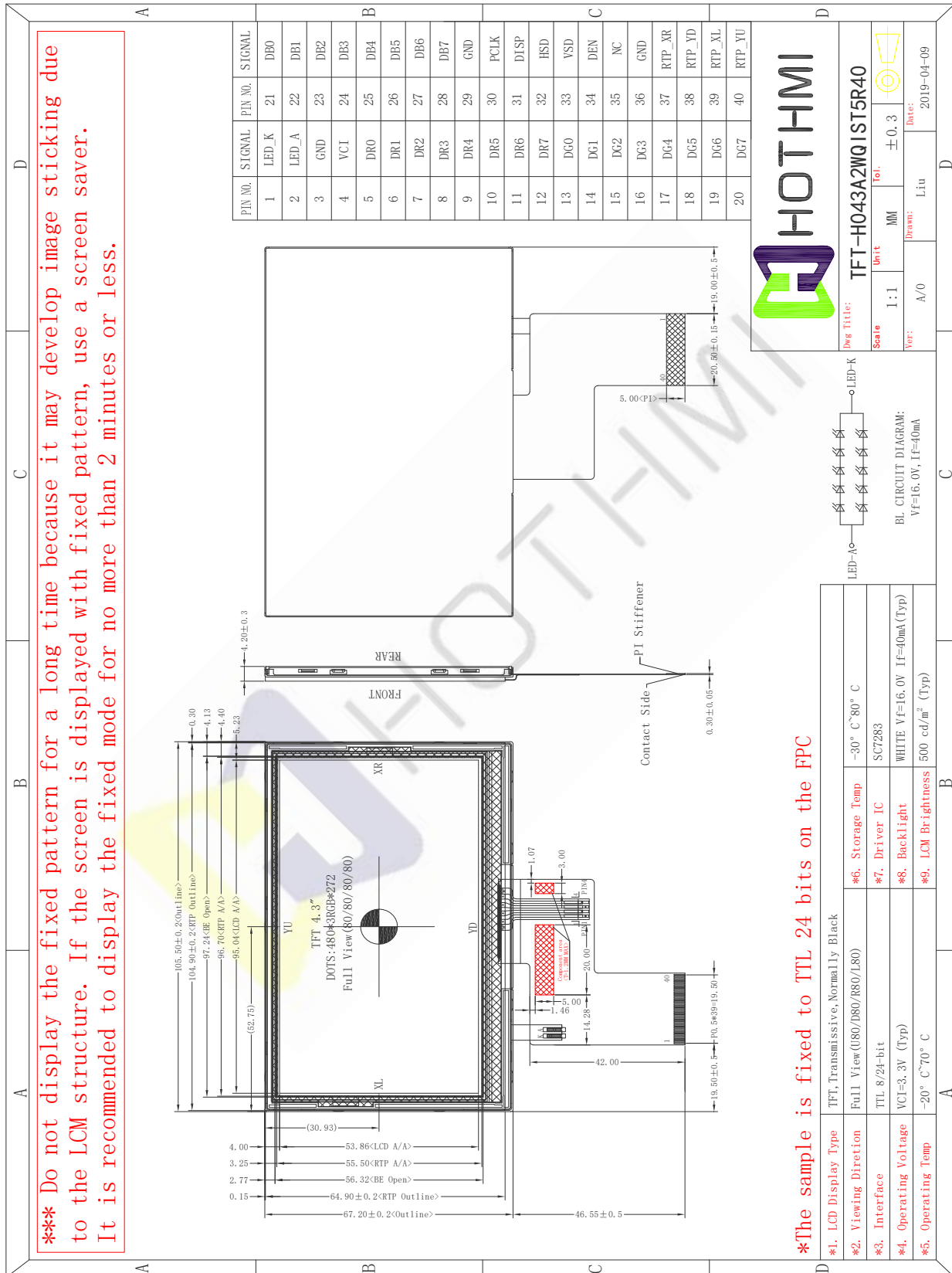

### 3. Pin Description

#### 3.1 Pin Description

Pin NO.	Symbol	Description
1	LED_K	LED Cathode
2	LED_A	LED Anode(+16V/40mA)
3	GND	Ground
4	VCI	Analog Power(3.0 ~ 3.6 V,3.3V)
5-12	DR0-DR7	Red data bus.If not used, please fix this pin at GND.
13-20	DG0-DG7	Green data bus.DG[7:0] are used in 8-bit RGB interface.
21-28	DB0-DB7	Blue data bus.If not used, please fix this pin at GND.
29	GND	Ground
30	PCLK	Pixel clock input pin
31	DISP	Display on/off (DISP=L:Standby mode;DISP=H:Normal display mode)
32	HSD	Horizontal sync signal, default is negative polarity.
33	VSD	Vertical sync signal, default is negative polarity.
34	DEN	Data input enable. Display access is enabled when DE is "H" .
35	NC	No Connector
36	GND	Ground
37	RTP_XR	Resistive TP function pin.If not used, let this pin open.
38	RTP_YD	Resistive TP function pin.If not used, let this pin open.
39	RTP_XL	Resistive TP function pin.If not used, let this pin open.
40	RTP_YU	Resistive TP function pin.If not used, let this pin open.

---END---

#### 3.2 Wiring Diagram

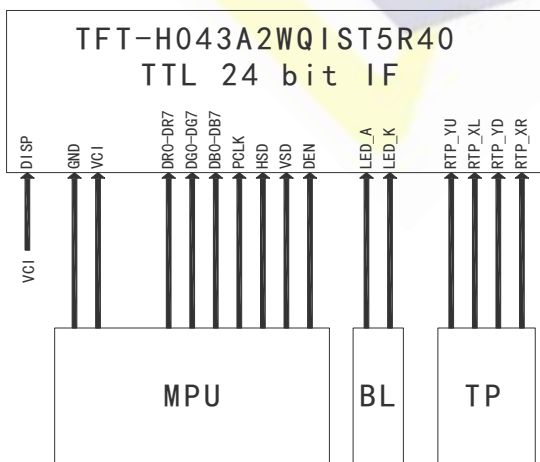

\*The sample is fixed to TTL 24 bits on the FPC

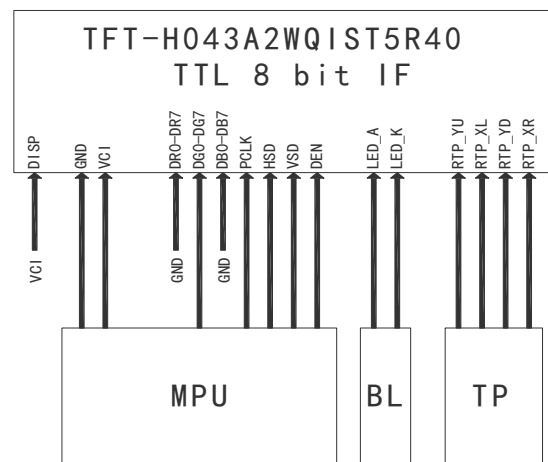

\* Also need to change the resistance position on the FPC from R12 to R11

## 4. Electrical Characteristics

### 4-1 TFT LCD Module Operating Conditions

Item	Symbol	Condition	Min	Type	Max	Unit
Interface logic circuits	IOVCC	-	-	-	-	V
Analog Power supply	VCI	-	3.0	3.3	3.6	V
TFT Gate on voltage	VGH	-	10.0	-	16.0	V
TFT Gate off voltage	VGL	-	-16.0	-	-10.0	V

### 4-2 LED back light specification (pera chip)

Item	Symbol	Condition	Min	Type	Max	Unit
Forward voltage	Vt	If=20mA	15.0	16.0	17.0	V
Forward current	Ipn	/1-chip	-	40	-	mA
Luminance(With LCD)	Lv	If=40mA	-	500	-	cd/m <sup>2</sup>
Luminous color	White					

## 5. OPTICAL SPECIFICATION

### 5.1 Overview

The test of Optical specifications shall be measured in a dark room (ambient luminance 1lux and temperature = 25 ± 2°C) with the equipment of Luminance meter system (Goniometer system and TOPCON BM-5) and test unit shall be located at an approximate distance 50cm from the LCD surface at a viewing angle of  $\theta$  and  $\Phi$  equal to 0°. The center of the measuring spot on the Display surface shall stay fixed. The backlight should be operating for 30 minutes prior to measurement.

### 5.2 Optical Specifications

Parameter		Symbol	Condition	Min.	Typ.	Max.	Unit	Remark
Viewing Angle Range	Horizontal	$\ominus$ L	CR>10	70	80	-	Deg.	Note 1
		$\ominus$ R		70	80	-	Deg.	
	Vertical	$\ominus$ U		70	80	-	Deg.	
		$\ominus$ D		70	80	-	Deg.	
Contrast ratio		CR	$\ominus = 0^\circ$	640	800	-		Note2
Color Gamut		CG		45	50	-	%	
White Chromaticity		Wx		-	(0.320)	-		
		Wy		-	(0.345)	-		
Reproduction of color	Red	Rx	$\ominus = 0^\circ$	-	(0.629)	-		Note4 (Based on C Light)
		Ry		-	(0.326)	-		
	Green	Gx		-	(0.337)	-		
		Gy		-	(0.546)	-		
	Blue	Bx		-	(0.136)	-		
		By		-	(0.143)	-		
Response Time (Rising + Falling)		Tr+Tf	$\ominus = 0^\circ$ Ta= 25°C	-	30	40	ms	Note5
Transmittance(with Polarizer)		Tr		-	(6.6)	-	%	Note3

### Note:

1. Viewing angle is the angle at which the contrast ratio is greater than 10. The viewing angles are determined for the horizontal or 3, 9 o' clock direction and the vertical or 6, 12 o' clock direction with respect to the optical axis which is normal to the LCD surface (see FIGURE 1).

2. Contrast measurements shall be made at viewing angle of  $\ominus = 0$  and at the center of the LCD surface. Luminance shall be measured with all pixels in the view field set first to white, then to the dark (black)

state . (see FIGUR 1) Luminance Contrast Ratio (CR) is defined mathematically.

$$CR = \frac{\text{Luminance when displaying a white raster}}{\text{Luminance when displaying a black raster}}$$

3. Transmittance is the Value without APF and without CG.

4. The color chromaticity coordinates specified in the above table shall be calculated from the spectral data measured with all pixels first in red, green, blue and white. Measurements shall be made at the center of the panel.

5. The electro-optical response time measurements shall be made as FIGURE 2 by switching the “data” input signal ON and OFF. The times needed for the luminance to change from 10% to 90% is  $T_r$ , and 90% to 10% is  $T_f$ .

**Figure1 Measurement Set Up**

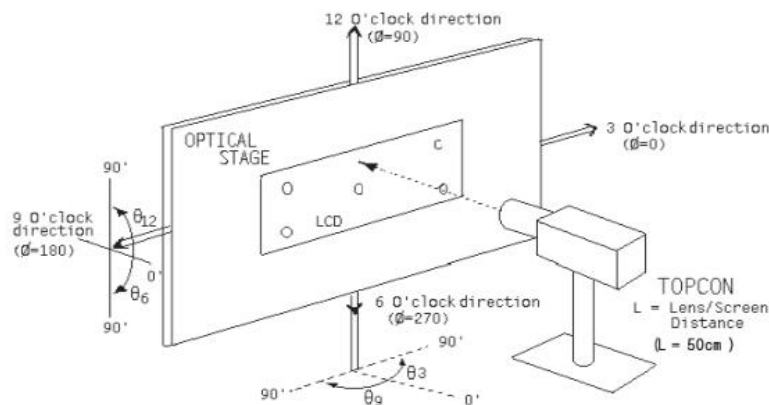

**Figure2 Response Time Testing**

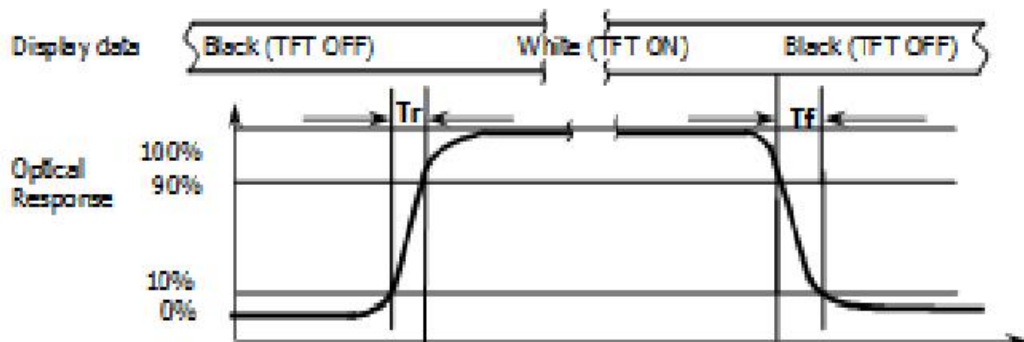



## 6. Timing Characteristics of Input Signals

### 6-1 SYNC Mode

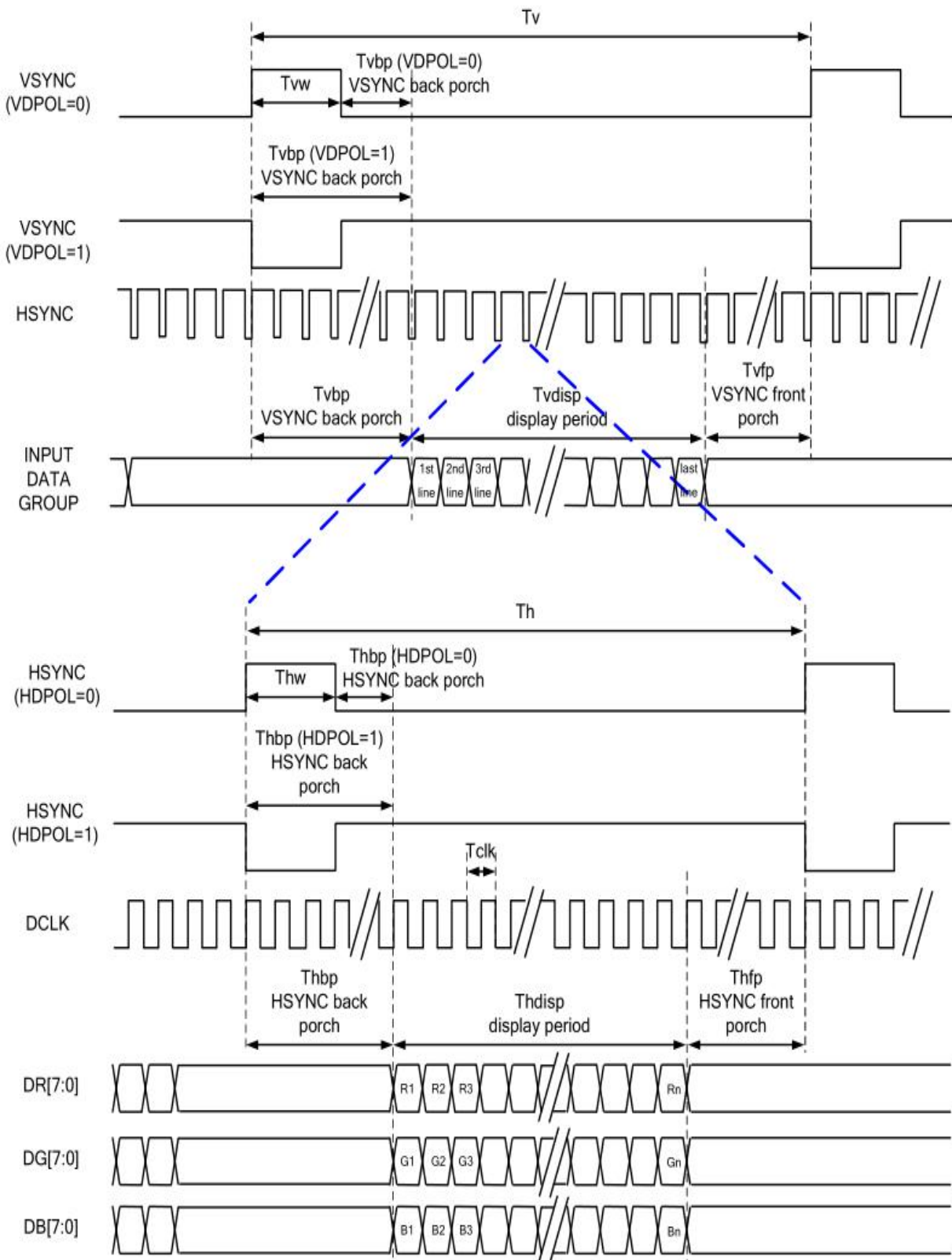

## 6-2 SYNC-DE Mode

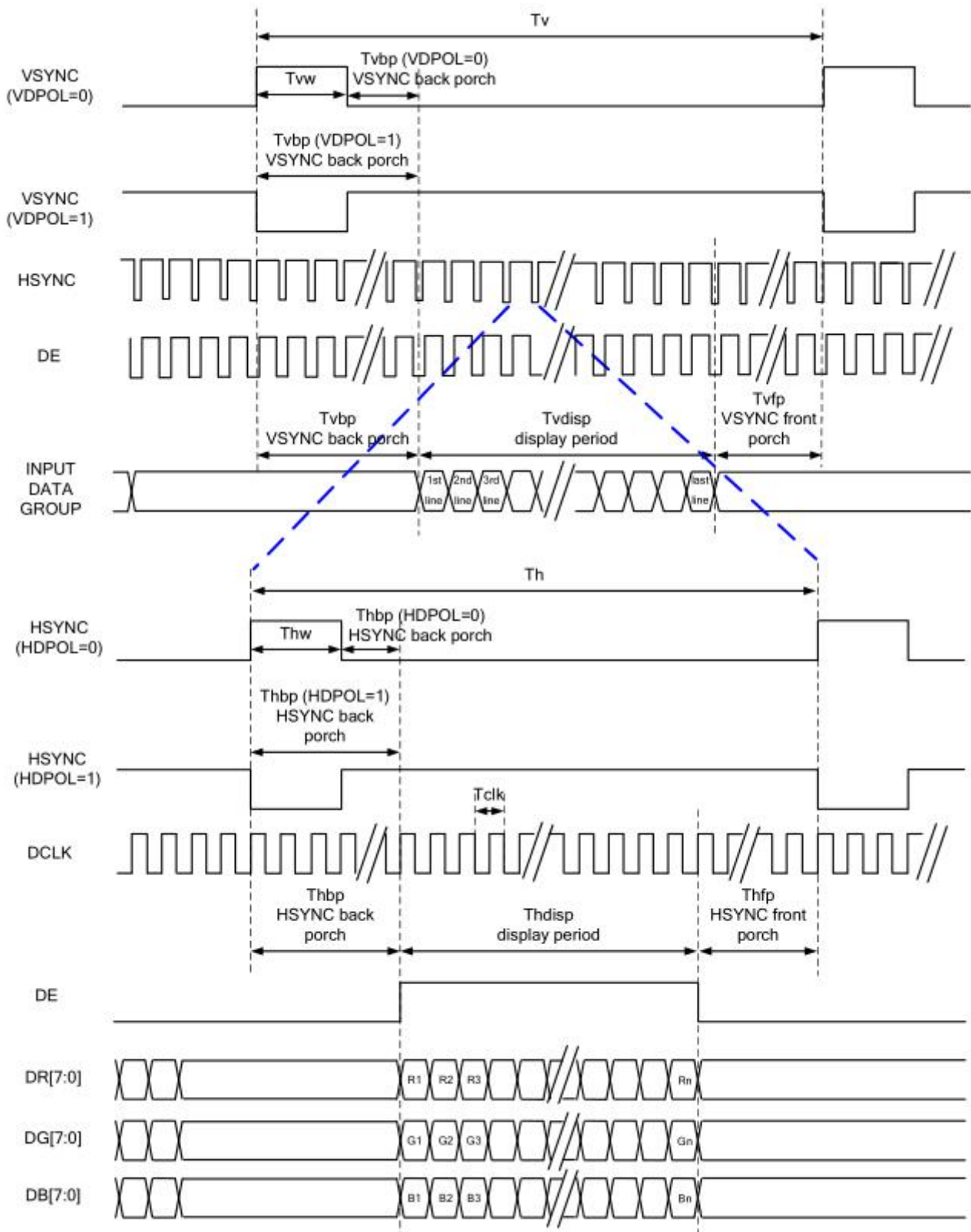

### 6-3 DE Mode

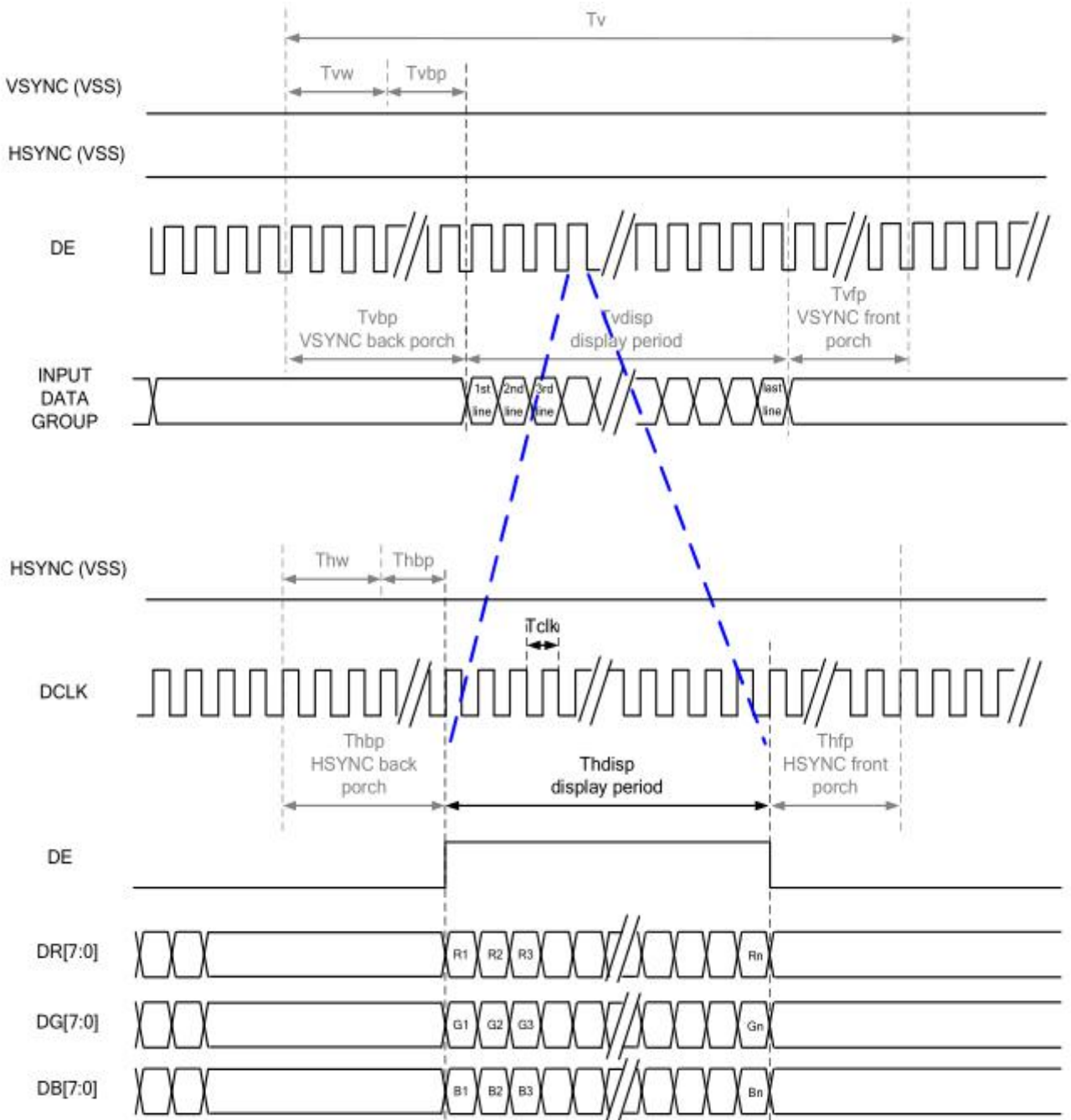

RGB Mode Selection Table	DCLK	HSYNC	VSYNC	DE
SYNC - DE Mode	Input	Input	Input	Input
SYNC Mode	Input	Input	Input	GND
DE Mode	Input	GND	GND	Input

Note: "Input" means these signals are driven by host side.

### 6-4 Parallel 24 bit RGB Input Timing Table

Parallel 24-bit RGB Input Timing (PVDD=VDD=VDDI= 3.3V, AGND= 0V, TA=25°C)

480RGB X 272 Resolution Timing Table							
Item	Symbol	Min.	Typ.	Max.	Unit	Remark	
DCLK Frequency	Fclk	8	9	12	MHz		
DCLK Period	Tclk	83	111	125	ns		
HSYNC	Period Time	Th	485	531	598	DCLK	
	Display Period	Thdisp		480		DCLK	
	Back Porch	Thbp	3	43	43	DCLK	By H_BLANKING setting
	Front Porch	Thfp	2	8	75	DCLK	
	Pulse Width	Thw	2	4	43	DCLK	
VSYNC	Period Time	Tv	276	292	321	HSYNC	
	Display Period	Tvdisp		272		HSYNC	
	Back Porch	Tvbp	2	12	12	HSYNC	By V_BLANKING setting
	Front Porch	Tvfp	2	8	37	HSYNC	
	Pulse Width	Tvw	2	4	12	HSYNC	

Note: It is necessary to keep Tvbp =12 and Thbp =43 in sync mode. DE mode is unnecessary to keep it.

### 6-5 Serial 8 bit RGB Input Timing Table

Serial 8-bit RGB Input Timing (PVDD=VDD=VDDI= 3.3V, AGND= 0V, TA=25°C)

480RGB X 272 Resolution Timing Table							
Item	Symbol	Min.	Typ.	Max.	Unit	Remark	
DCLK Frequency	Fclk	24	27	30	MHz		
DCLK Period	Tclk	33	37	42	ns		
HSYNC	Period Time	Th	1445	1491	1558	DCLK	
	Display Period	Thdisp		1440		DCLK	
	Back Porch	Thbp	3	43	43	DCLK	By H_BLANKING setting
	Front Porch	Thfp	2	8	75	DCLK	
	Pulse Width	Thw	2	4	43	DCLK	
VSYNC	Period Time	Tv	276	292	321	HSYNC	
	Display Period	Tvdisp		272		HSYNC	
	Back Porch	Tvbp	2	12	12	HSYNC	By V_BLANKING setting
	Front Porch	Tvfp	2	8	37	HSYNC	
	Pulse Width	Tvw	2	4	12	HSYNC	

Note: It is necessary to keep Tvbp =12 and Thbp =43 in sync mode. DE mode is unnecessary to keep it.

## 7. RELIABILITY TEST

### 7-1 Temperature and Humidity

TEST ITEMS	CONDITIONS	NOTE
High Temperature Operation	60°C ; 120hrs	
High Temperature Storage	70°C ; 120hrs	
High Temperature High Humidity Operation	60°C; 90%RH ; 120hrs (No condensation)	
Low Temperature Operation	-10°C ; 120hrs	
Low Temperature Storage	-20°C ; 120hrs	
Thermal Shock	-30°C (0.5hr) ~ 80°C (0.5hr) ; 100 Cycles	Non-Operating
Image Sticking	25°C ; 2hrs	1

Note 1: Condition of Image Sticking test: 25°C ±2°C

Operation with test pattern sustained for 4 hrs, then change to gray pattern immediately. After 5 mins, the mura must be disappeared completely .

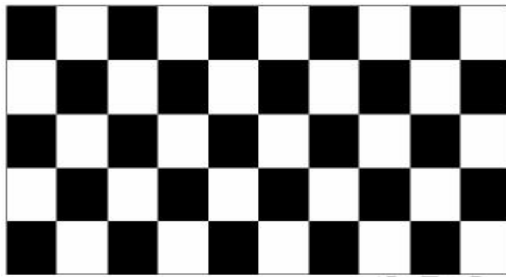

(a) Test Pattern (chess board Pattern )



(b) Gray Pattern

### 7-2 Shock and Vibration

ITEMS	CONDITIONS
Packing Shock (Non-Operation)	<ul style="list-style-type: none"> <li>● Shock level:980m/s<sup>2</sup></li> <li>● Waveform:1/2 Sine wave,6msec</li> <li>● ±X, ±Y ±Z,each axis 1 times</li> </ul>
Packing Vibration (Non-Operation)	<ul style="list-style-type: none"> <li>● Frequency range:8-33.3HZ</li> <li>● Stoke:1.0mm</li> <li>● Sweep: 10Hz-50Hz</li> <li>● x,y,z 2 hours for each direction</li> </ul>

### 7-3 Electrostatic Discharge

TEST ITEM	CONDITIONS
ESD (Non-operation)	150pF,330Ω , Contact±4KV,Air :±8KV.Note 1
	200pF,0Ω , ±200V Contact test.Note 2

Note:Measure Point:

- 1.LCD glass and metal bezel
- 2.IF connector pins

## 8.HANDDLING & CAUTIONS

### 8-1 Caution For Operation

◆Since the LCM is made of glass, do not apply strong mechanical impact or static load onto it. Handling with care since shock, vibration, and careless handling may seriously affect the product. If it falls from a high place or receives a strong shock, the glass maybe broken.

◆It is indispensable to drive the LCM within the specified voltage limit since the higher voltage than the limit causes LCM's life shorter. An electro-chemical reaction due to DC causes undesirable deterioration of the LCM so that the use of DC drive should avoid.

◆Do not connect or disconnect the LCM to or from the system when power is on.

◆Never use the LCM under abnormal conditions of high temperature and high humidity.

◆When expose to drastic fluctuation of temperature(hot to cold or cold to hot), the LCM may be affected; specifically, drastic temperature fluctuation from cold to hot, produces dew on the LCM's surface which may affect the operation of the polarizer on the LCM.

◆Response time will be extremely delay at lower temperature than the operating temperature range and on the other hand LCM may turn black at temperature above its operational range. However those phenomenon do not mean malfunction or out of order with the LCM. The LCM will revert to normal operation once the temperature returns to the recommended temperature range for normal operation.

◆Do not display the fixed pattern for a long time because it may develop image sticking due to the LCM structure. If the screen is displayed with fixed pattern, use a screen saver. It is recommended to display the fixed mode for no more than 2 minutes or less.

◆Do not disassemble and/or re-assemble LCM module

### 7-2 Caution Against Static Charge

◆The LCM use C-MOS LSI drivers, so customers are recommended that any unused input terminal would be connected to Vdd or Vss, do not input any signals before power is turn on, and ground you body, work/assembly area, assembly equipments to protect against static electricity.

◆Remove the protective film slowly, keeping the removing direction approximate 30-degree not vertical from panel surface, if possible, under ESD control device like ion blower, and the humidity of working room should be kept over 50%RH to reduce the risk of static charge.

◆Avoid the use work clothing made of synthetic fibers. We recommend cotton clothing or other conductivity-treated fibers.

◆In handling the LCM, wear non-charged material gloves. And the conducting wrist to the earth and the conducting shoes to the earth are necessary

--END--